

Thank you for your purchase of this Magnasonic product. Please read this user manual carefully before using product to ensure proper use. Keep this manual in a safe place for future reference.

magnasonic.com/support

We reserve the right to change models, configurations, or specification without notice or liability. Product may not be exactly as shown. © MAGNASONIC®, MAGNASONIC®, the MAGNASONIC® marks may be registered. All other trademarks are property of their respective owners

Important Safety Instructions

Safety Alerts

If any of the following conditions are present, stop using immediately, unplug the power cord, and refer to a qualified service professional for servicing:

- A. If there is any smoke or unusual smell while using.
- B. If the product has been exposed to rain, water, or other liquids.
- C. If the product does not operate normally by following the operating instructions.
- D. If the product exhibits a distinct change in performance.
- E. If the product has been dropped or damaged in any way.

Best Practices for Safe Use

- 1. Only use films of standard size.
- 2. Only use attachments/accessories specified by the manufacturer.
- 3. Unwind and straighten the USB cord before use.
- 4. Check that the power voltage stated on the rating label corresponds to your local electricity supply.
- 5. Unplug the power adapter from the wall when the product is unused for a long period of time and during thunderstorms.
- 6. Do not use this product near water.
- 7. Do not immerse this product, the power cord, or any accessories in water or any other liquid.
- 8. Do not block any ventilation openings. Install in accordance to the manufacturer's instructions.
- 9. Do not place this product near any heat sources such as radiators, heat registers, stoves, or other apparatus (including amplifiers) that produce heat.

10. Do not attempt to service or disassemble this product yourself as opening or removing covers may expose you to dangerous voltages or other hazards.

Maintenance

1. Please make sure the scanner is clean before using.
2. Do not use liquid cleaners.
3. Clean outside of the product only with a dry cloth.
4. Do not clean the inside of this product with anything except for the included cleaning brush.
5. To clean with the included cleaning brush, insert the soft end of the brush into the film/slide holder slot. Carefully push the brush around inside to get rid of any dust or debris that may be on the lens.

MAGNASONIC

Since 1954, Magnasonic has been a leader in developing innovative and unique products. We are dedicated to empowering people using six key fundamentals: superior quality, performance, simplicity, style, value and a fanatical obsession with outstanding customer service. At Magnasonic, our mission is a simple one – create people-driven products that make life's daily adventures easier and more fun. We believe everyday experiences should be extraordinary.

Thank you for your purchase of this Magnasonic® product.
We hope you enjoy your experience.

Questions?

Give us a chance to help, we're just a click away.



[Magnasonic.com/videos](https://magnasonic.com/videos)



[Magnasonic.com/resources](https://magnasonic.com/resources)



[Magnasonic.com/support](https://magnasonic.com/support)



[Magnasonic.com/contact](https://magnasonic.com/contact)

Don't forget to register your product with us!

[Magnasonic.com/registration](https://magnasonic.com/registration)

Table Of Contents

What's Included.....	6
Product Information	7
Operating Instructions	8
Powering on Your Film Scanner.....	8
Changing the Language.....	8
Prepping Your Film/Slides.....	8
Preparing the Film Scanner.....	11
Cleaning and Care.....	11
Using an SD Card.....	12
Formatting Your SD Card.....	12
Scanning Your Images.....	12
Viewing Your Scanned Images.....	13
Transferring Images To Your Computer	14
Watching Saved Images From a TV Screen	14
FAQ/Troubleshooting.....	15
Specifications.....	17
FCC Information	18
Magnasonic® Warranty.....	18

What's Included



Film Scanner



Power Adapter



USB Cable



TV Out Cable



Cleaning Brush

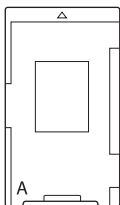

Negative Adapter

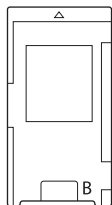

Slide Adapter



User Manual

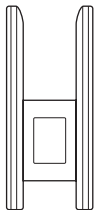

110 Slide Insert



110 Negative Insert

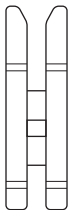

Super 8 Insert

Product Information

Front

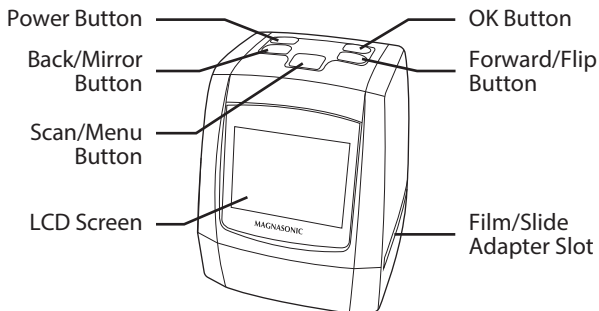

Back

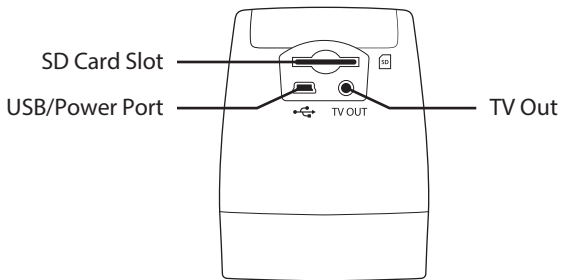

Operating Instructions

Powering on Your Film Scanner

1. Connect the USB cable to the USB port on the film scanner.
2. Connect the other end of the USB cable into the included USB wall adapter. Plug the wall adapter into a power outlet.
3. Press and hold the Power button on the scanner to turn it on.
NOTE: *The FS50 will automatically shut off after 10 minutes of inactivity.*

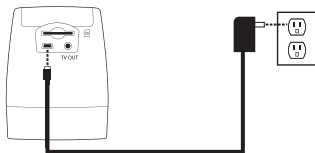

Changing the Language

1. On the Main Menu, go to LANGUAGE and press OK.
2. You may now select the language of your choice by using the < and > buttons to scroll between the available selections.
 - English
 - Italiano
 - Espanol
 - Japanese
 - Francais
 - Simplified Chinese
 - Deutsch
 - Traditional Chinese
3. Press the OK button to select the language.

Prepping Your Film/Slides

IMPORTANT: Ensure your slides/film are clean and free of dirt or debris

1. Open the appropriate slide/film adapter and insert your slide/film. Each adapter is labelled to identify it. If you are not certain of your slide/film type refer to the images below.
2. Ensure the slide/film is facing the correct way and is not bent.
3. Close the slide or film adapter and press the edges so that it locks into place.

Slide Types



35mm Slide (135)

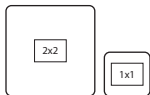

110 Slide



126 Slide

Film Types

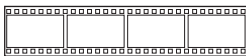

135 Negative (35mm)



110 Negative

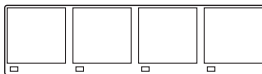

126 Negative

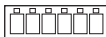

Super 8

Slide Adapters

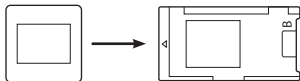

35mm Slide (135)

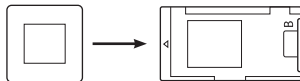

126 Slide

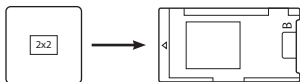

110 Slide

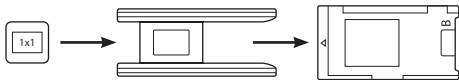

110 Slide

Negative Adapters

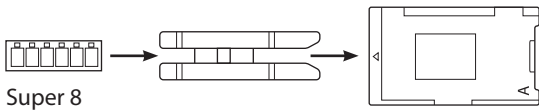
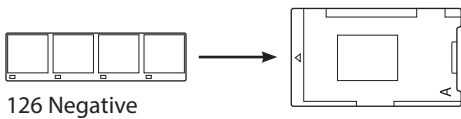
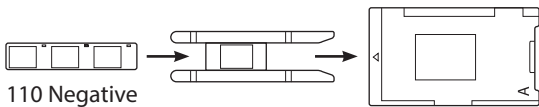
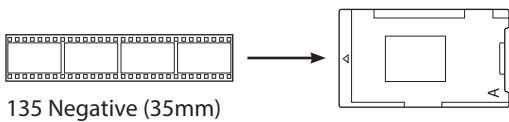

Preparing the Film Scanner

1. Press and hold the Power button on the scanner to turn it on.
2. Insert the prepared film or slide adapter into the slot on the right side of the film scanner.
3. In the Main Menu use the arrow keys to highlight the FILM TYPE option and press the OK button to select it.
4. Use the > arrow key to cycle through Negatives, Slides, or B&W. Press the OK button to select it.
5. The next screen will show the different sizes of your selection. Use the > arrow key to select the correct size and press the OK button.

IMPORTANT: The quality of the original slide/film will impact the quality of the scanned image.

Cleaning and Care

Use the included cleaning brush to ensure there is no dust or debris on the lens. Insert the soft end of the brush, face down, into the film/slide holder slot. Carefully push the brush around inside to get rid of any dust or debris that may be on the lens.

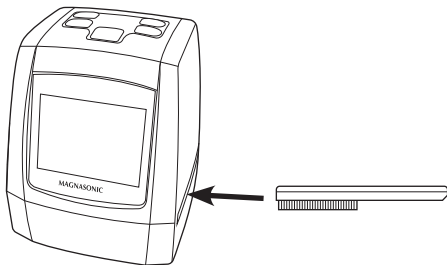

Using an SD Card

NOTE: This scanner has 128MB of built-in memory for saving scanned images. This film scanner will also accept SD, SDHC, and SDHX cards with a maximum of 128GB for extra memory. If you are using a 128GB SD card, it may need to be formatted before using for the first time. Please see below for formatting instructions.

1. Insert the SD card, label down, into the SD card slot located at the back of the film scanner. The SD card will click in if inserted properly.
2. Remove the SD card by pressing on it until it clicks and pops out, then remove it from the slot.

Formatting Your SD Card

WARNING: Formatting your SD card will delete all files stored on the SD card. Download your files from your SD card to your computer before formatting.

1. In the Main Menu, go to FORMAT. Press the OK button.
2. When prompted if you would like to format the SD, use the < button to choose "Yes". Press the OK button to begin formatting the SD card.

Scanning Your Images

1. Press the SCAN button to select Capture mode and press OK.
2. You should now see your film or slide image on the screen and the corresponding film/slide type is listed at the lower left corner.

NOTE: Image on screen does not reflect scanned image quality.

3. To adjust Brightness or Color, press the OK button. Use the left/right arrows to move between Brightness (EV), Red (R), Green (G), or Blue (B). Press the OK button to adjust them individually.
4. Once all settings are correct, press the SCAN button to return.

5. You can also mirror or flip your image before scanning by pressing the < or > buttons.
 - < – Mirror
 - > – Flip
6. Once ready, press the SCAN button and press OK to capture and save your image to the internal memory or SD card if one is inserted. The FS50 cannot scan directly to a computer.
7. If you have multiple slides/negatives you can push/pull them through the adapter without removing it. See image below for reference.

NOTE: When inserting film/negative strips use caution to ensure they are not bent or damaged.
8. You can press the MENU button twice to return back to the Main Menu when your scanning is done.

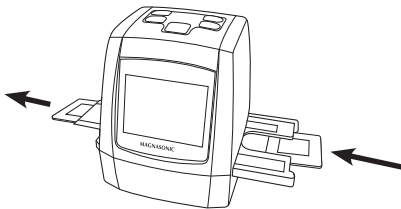

Viewing Your Scanned Images

1. To view your saved images, go to GALLERY and press the OK button.
2. Your images will play automatically in Slideshow mode.
3. To manually review your saved images and stop Slideshow mode, press the OK button.

4. Use the left and right buttons to scroll through each saved image.
5. Press the OK button again to open the Gallery options. You can choose to either go back to Slideshow mode, delete the image, or return to the Main Menu.

Transferring Images to Your Computer

IMPORTANT: *The FS50 cannot scan directly to a computer. Scanning must be completed on the FS50.*

1. Ensure your computer is powered on.
2. Connect the film scanner to your computer via the included USB cable.
3. Power on the film scanner.
4. In the film scanner menu, select USB MSDC.
5. A new folder will appear on your computer. Your saved images can be found here. You can now move these images from your scanner directly onto your computer.

Watching Saved Images from a TV Screen

1. Turn on the film scanner.
2. Connect the included TV Out cable to the TV Out port on the back of the film scanner.
3. Connect the other end of the cable into the Video input on your TV.

NOTE: *When you connect the film scanner to your TV, the scanner's LCD screen will turn off automatically.*

4. Ensure that your TV is set to the proper input/video source.
5. You should now see the film scanner's screen on your TV screen.

FAQ / Troubleshooting

Issue	Solution
How can I get the best quality scan possible?	Ensure the film/slides are clean and that you clean the inside of the scanner with the included cleaning brush immediately before scanning. See pg. 11 for instructions on how to use the cleaning brush.
How should I prepare the film/slides to ensure the best possible scan?	The film/slide should be free of any dust/fingerprints. This can be done with an appropriate cleaning cloth.
I've noticed a consistent spot on every slide I have scanned. Is something wrong with my scanner?	There is likely a small amount of dust inside your unit. Use the included cleaning brush to ensure there is no foreign debris. See pg. 11 for instructions on how to use the cleaning brush.
Do I need a computer to begin scanning?	Everything is plug-and-play right out of the box. You can save images to an SD card (up to 128GB) or the scanner's internal memory (128MB). You can then export to a computer at a time that is more convenient.
What file format are the images saved as?	The files are automatically saved in JPG format.
The scanner screen is black but it has power.	Ensure the TV Out cable is not connected to the back of the film scanner.

Issue	Solution
Can I use this to scan raw film or do I need to develop the negatives first?	The scanner will work for developed film only.
I cannot see all my images on the computer.	If an SD Card is inserted your computer will only see images saved on the SD Card. The SD Card must be removed to see images saved on the internal storage.
TV Out image is not showing on my TV.	The FS50 uses NTSC for it's video output format. If your TV requires a PAL signal, disconnect the TV Out cable, go to TV Out in the Main Menu and select PAL.
Where can I recycle my old slides, negatives, film?	Older film and photos can contain chemicals that make them difficult to recycle. For proper recycling/disposal information please consult with your local recycling company.
My slides/negatives scanned images have faded colors.	Over time slides and negatives can degrade and the colors fade. Ensure your slides/negatives are clean and use the color adjustment options when scanning.
The colors in my scanned images are reversed/negative.	Change the film type in the menu to Negative to scan properly.

Specifications

Display	2.4" Color TFT LCD
Focus Range	Fixed Focus
Exposure Control	Automatic / Manual (-2.0 EV~ +2.0EV)
White Balance	Automatic
Resolution	14 Megapixels / 22 Megapixels (interpolation)
Picture Aspect Ratio	3:2
Scan Quality	3200 dpi & 4000 dpi (interpolation)
Scan Method	Single Image Scanning
Scan Speed	3-5 seconds
Film Type	Slide: 135, 110, 126 Negatives: 35mm, 110, 126, Super 8
Light Source	LED Back Light
File Format	JPEG/Still Image
Image Playback	Single
TV Out Type	NTSC/PAL
Built-in Memory	128MB
External Memory Card	SD card up to 128GB
Power Supply	DC 5V (USB Adapter)
Dimensions	4.0 x 3.4 x 3.4 inches (101.6 x 86.4 x 86.4mm)
Weight	0.66 lbs (0.30kg)
Product Certifications	FCC, RoHS, CE, UL/CUL

FCC Information



This equipment has been tested and found to comply with the limits for a Class B digital device, pursuant to part 15 of the FCC Rules. These limits are designed to provide reasonable protection against harmful interference in a residential installation. This equipment generates, uses and can radiate radio frequency energy and, if not installed and used in accordance with the instructions, may cause harmful interference to radio communications. However, there is no guarantee that interference will not occur in a particular installation. If this equipment does cause harmful interference to radio or television reception, which can be determined by turning the equipment off and on, the user is encouraged to try to correct the interference by one or more of the following measures:

- Reorient or relocate the receiving antenna.
- Increase the separation between the equipment and receiver
- Connect the equipment into an outlet on a circuit different from that to which the receiver is connected.
- Consult the dealer or an experienced radio/TV technician for help.

NOTE: This unit may contain a microcomputer for signal processing and control function. In very rare situations, severe interference, noise from an external source, or static electricity may cause it to lockup. In the unlikely event that this should happen, turn off the unit, wait at least five seconds, and then turn it back on again.

Magnasonic® Warranty

Thank you for choosing Magnasonic. We guarantee your investment in our products is a solid one! Extensive thought, research, planning, and design goes into every product we make. High quality components combined with precision manufacturing allows us to maintain the highest possible production standards.

All items are guaranteed against defects in materials and craftsmanship. Magnasonic products come with a complete one year parts and labour warranty. Proof of purchase from an authorized Magnasonic dealer is required when seeking warranty assistance.

Magnasonic has outstanding quality control, if something should go wrong with any of our products, we will repair it free of charge! If the product cannot be repaired, we will replace the product. If the product has been discontinued, we will replace the product with either the newest version of said product or current equivalent. Replacement parts furnished in connection with this warranty shall be warranted to a period equal to the unexpired portion of the original product warranty.

Thank you for choosing Magnasonic. We guarantee your investment in our products is a solid one! Extensive thought, research, planning, and design goes into every product we make. High quality components combined with precision manufacturing allows us to maintain the highest possible production standards. All items are guaranteed against defects in materials and craftsmanship. Magnasonic products come with a complete one year parts and labour warranty. Proof of purchase from an authorized Magnasonic dealer is required when seeking warranty assistance.

Magnasonic has outstanding quality control, if something should go wrong with any of our products, we will repair it free of charge! If the product cannot be repaired, we will replace the product. If the product has been discontinued, we will replace the product with either the newest version of said product or current equivalent. Replacement parts furnished in connection with this warranty shall be warranted to a period equal to the unexpired portion of the original product warranty.

This warranty shall not apply to:

- A. Any defects caused or repairs required as a result of abusive operation, negligence, accident, improper installation or inappropriate use as outlined in the owner's manual.
- B. Any Magnasonic product tampered with, modified, adjusted or repaired by any party other than Magnasonic.
- C. Any cosmetic damage to the surface or exterior that has been defaced or caused by normal wear and tear.
- D. Any damage caused by external or environmental conditions, including but not limited to transmission line/power line voltage or liquid spillage.
- E. Any product received without appropriate model, serial number, and CSA/cUL/cULus/cETL/cETLus markings.
- F. Any products used for rental or commercial purposes.
- G. Any installation, setup and/or programming charges.
- H. Defect or damage as a result of connecting a product to an outlet with the incorrect voltage. Voltage converters must be used where applicable.

If in any situation your purchase displays a manufacturer's defect during the warranty period and does not function correctly, Magnasonic will repair your product and cover all parts, labour, and return costs upon delivery of the Magnasonic product together with proof of purchase.

Products returned to Magnasonic for warranty service must be shipped prepaid (paid by customer). Products must be shipped in the original shipping container or its equivalent; in any case the risk of loss or damage in transit is to be borne by you.

We believe everyday experiences should be extraordinary. We pledge to work with you in resolving any issue that occurs with your product. If you are in need of assistance do not hesitate to visit our support page at www.magnasonic.com/support/